

13mm DIAMETER BALUSTRADE PIVOT ASSEMBLY

FXI3 BPA

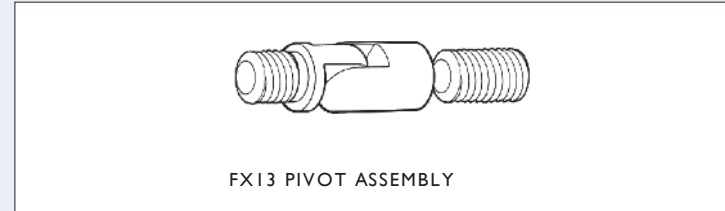

FXI3 BPA PACK:

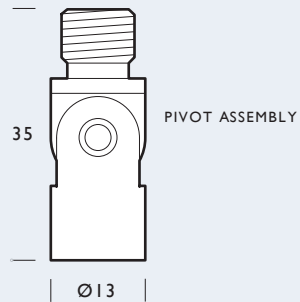

FXI3 BW BODY WASHER

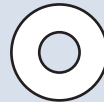

O.D Ø21
I.D Ø10

OPTIONAL BODY WASHER

FASTENERS M10:

fasteners supplied with M10 stud

FXCS CAP SCREW

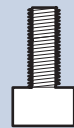

FXMA MASONRY ANCHOR LOXIN



FXFP FACE PLATE

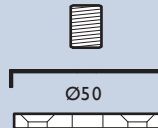

FXTI THREADED INSERT



FXTB TOGGLE BOLT

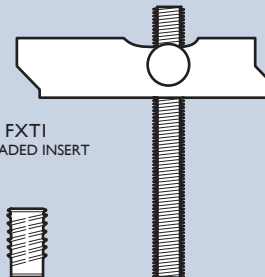

FXAT 100mm ALL THREAD *can be used with chemset glue*



FXLB LAG BOLT

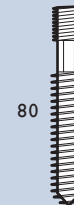

FXI3BPA:

Balustrade Pivot Assembly

- The FXI3BPA is a swinging pivot for fixing cables at any angle required.
- The FXI3BPA can only be used in conjunction with an FXI3BDW or FXI3BLE

MATERIAL:

316 Grade Stainless Steel

THREAD:

M10

FINISH:

Satin Stainless Steel

LOCATION:

Interior and exterior applications

FXI3CBL:

Balustrade Cable

- 7x7 strand, Ø1/8" 316 Grade stainless steel cable

PRODUCT COMPLIANCY:

As FIX Systems are not certified engineers, it is the buyer's responsibility to ensure that the application of all FIX products is suitable for its intended use and that it is compliant with relevant safety standards.

